

LABORATORIO PREGEN
Carrera 15a No 106-42
BOGOTA

Batch 2029, Rack A, Plate 1, Well A08, 171931
[C833C7FDC777F1BF] Dec 29, 2025 11:06:20 Pressure = 76 bar (75 to 77)

FA

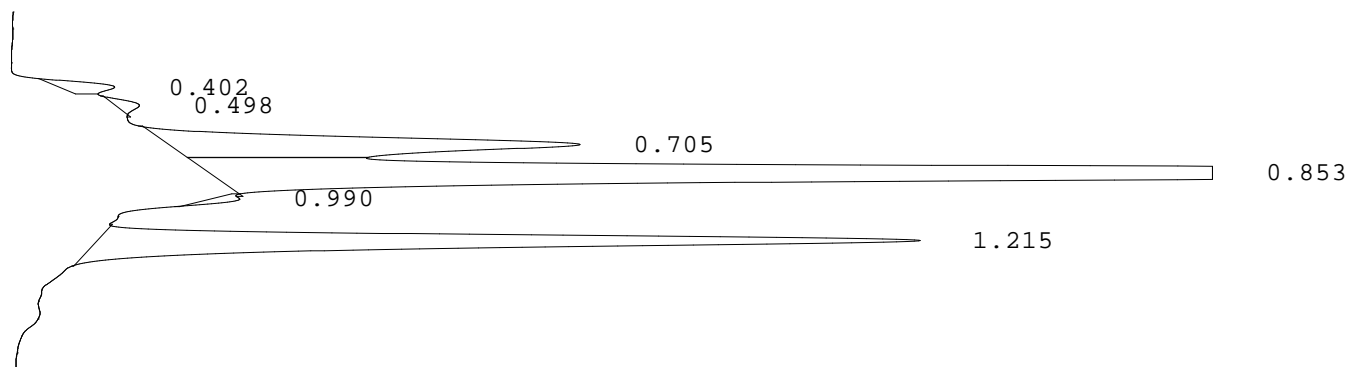

PEAK	RT	REL RT	% CONC	AREA	COMMENT
1	0.402	F 0.47	1.1%	16493	
2	0.498	F 0.59	0.6%	8460	
3	0.705	F 0.83	13.6%	198142	Acetylated F peak
4	0.853	F 1.01	62.0%	905237	Consistent with F
5	0.990	F 1.17	0.6%	9054	
6	1.215	A 1.01	22.1%	322586	A peak - REVIEW

Total Area: 1459972

- Codes:
- 1) Wide A peak
 - 2) Area of A peak < 80%
 - 3) Peak area greater than expected
 - 4) Peak after A2
 - 5) Alc > 10%
 - 6) HbF or variant present
 - 7) Total sample area too small/big
 - 8) A2 is not within normal range